

PRODUCT CATALOG

WWW.CHENTRONICS.COM

**TURBINE SYSTEMS
FLAME SCANNERS
EXCITERS IGNITERS &
RODS INPUT/OUTPUT CABLES**



TABLE OF CONTENTS

<u>ABOUT CHENTRONICS</u>	1
<u>WHAT WE DO BEST</u>	2
<u>EXCITERS</u>	3
<u>SureSpark LO</u>	
<u>SureSpark LO Dual</u>	
<u>SureSpark MTE</u>	
<u>SureSpark RF</u>	
<u>SmartSpark</u>	
<u>Motivator 3</u>	
<u>IGNITER SIZING GUIDE</u>	9
<u>CONNECTION GUIDE</u>	10
<u>HARNESSES AND RODS.....</u>	11
<u>IGNITERS</u>	12
<u>Boiler, Burner & Pilot Igniters</u>	
<u>Turbine Igniters</u>	
<u>TURBINE SYSTEMS</u>	14
<u>FLAME SCANNERS</u>	15
<u>iScan3+</u>	
<u>Fiber Optic Solutions & Accessories</u>	

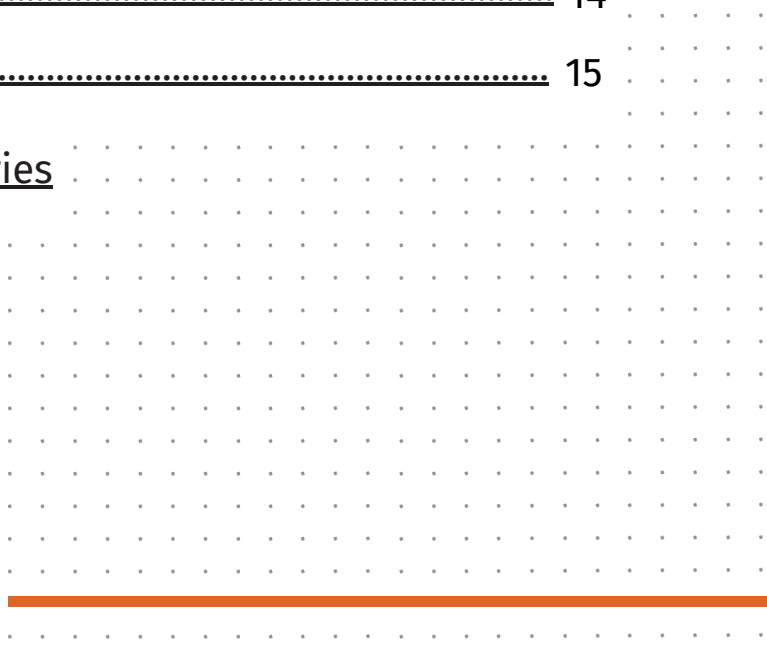



ABOUT US

Founded on the principles of innovation and excellence, Chentronics has been at the forefront of ignition technology solutions for over five decades. Our expertise lies in designing and manufacturing high-energy ignition systems for industrial applications, providing reliable and efficient solutions that enhance safety and performance.

At Chentronics, we are committed to delivering the highest quality products and services to our customers worldwide. Our state-of-the-art facility and dedicated team of professionals work tirelessly to ensure that our ignition systems meet the most stringent industry standards. We take pride in our ability to tailor solutions to the unique needs of our clients, fostering long-lasting partnerships built on trust and mutual success.

Innovation drives us forward, and continuous improvement is part of our DNA. As we look to the future, Chentronics remains dedicated to pushing the boundaries of technology, developing sustainable and efficient solutions.

Thank you for choosing Chentronics. We look forward to being your trusted partner in ignition technology.

CONTACT

To Order, Please Contact One of Our Trusted Partners:



For Technical Questions:

+1 (607) 334-5531
50 O'Hara Drive
Norwich, NY 13815

WWW.CHENTRONICS.COM/CONTACT

WHAT WE DO BEST

High Energy vs. High Tension Ignition

Traditional high tension ignition systems use high voltage transformers to create constant sparks across an open gap. These systems are prone to fouling from moisture and contaminants, struggle with liquid fuels, and require frequent igniter replacements in dual-fuel setups.

Chentronics High Energy Ignition uses low-voltage capacitor-stored energy to deliver powerful, precisely timed spark bursts. This design enables a self-cleaning igniter that resists contamination, supports multiple fuel types, and switches between liquid and gas fuels without hardware changes.

For critical combustion applications, Chentronics offers superior durability, efficiency, and fuel flexibility, ensuring better uptime and operational control.

IGNITER WEAR AND SPARK INDICATOR COLOR STATES

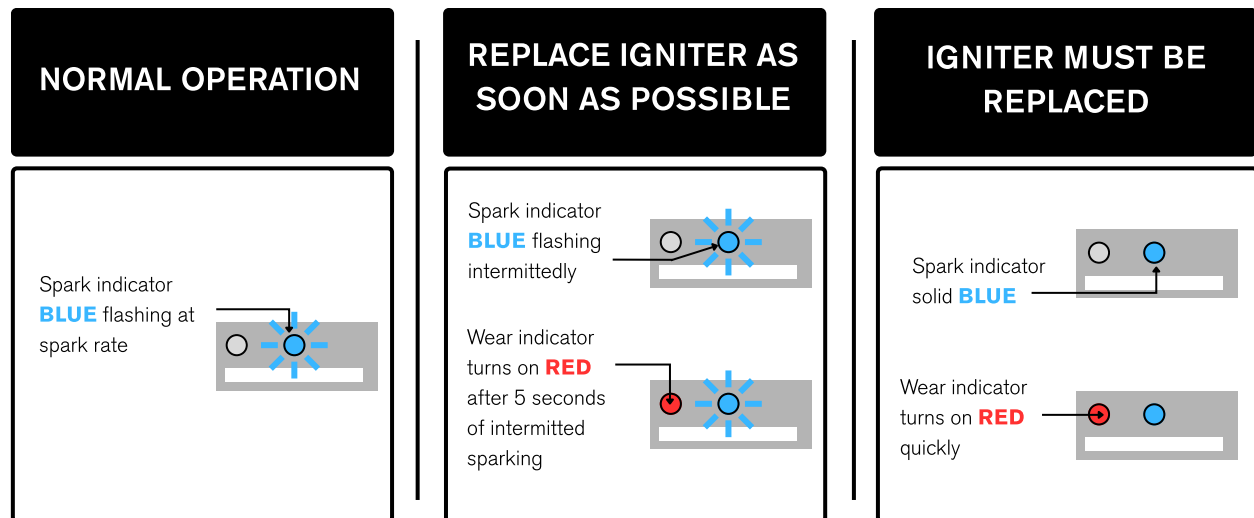

Chentronics Predictive Diagnostic Systems

Our high-energy ignition systems include a proprietary predictive diagnostics circuit, allowing operators to prevent missed starts proactively.

KEY BENEFITS

- **Real-Time Feedback:** Receive spark status updates via a blue light indicator or digital signals to your burner management system, depending on the exciter model.
- **Efficient Maintenance:** Get clear alerts when igniters need replacement, reducing missed starts and improving the safety of your testing process.
- **Enhanced Troubleshooting:** Cut down time and effort for system maintenance and diagnostics.

EXCITERS

SURESPARK LO (07070404)

Our most popular ignition system capable of handling all gaseous and light liquid fuels and has full Chentronics predictive diagnostic capabilities with indicator lights.







Key Features

- Input Power 100-240VAC
- Output 12 Joule @ 2, 4, or 6 Sparks Per Second (SPS)
- Various configurable output options

Certifications:  

TYPICAL SURESPARK LO SYSTEM WITH 02 SERIES OUTPUT HARDWARE FOR NON-HAZARDOUS AREA APPLICATIONS (NO. 2 OIL OR GAS)

	DESCRIPTION	FEATURES	TYPICAL PART NO.
SINGLE EXCITER	SURESPARK LO EXCITER	<ul style="list-style-type: none"> • 4SPS exciter • Diagnostic led indicators for tip wear • Output connection: two-wire MIL style • Stainless steel, painted steel or fiberglass enclosure • Optional momentary switch 	07070404-ZZ1 
	HARNESS	<ul style="list-style-type: none"> • Straight • Input and output connectors: two-wire MIL style 	03000350 
ONE NEEDED PER EXCITER OUTPUT	BASE ROD	INPUT CONNECTOR Two-wire MIL style	OUTPUT CONNECTOR 02 SERIES FEMALE 02000300 
	EXTENSION ROD (OPTIONAL)	INPUT CONNECTOR 02 SERIES MALE	OUTPUT CONNECTOR 02 SERIES FEMALE 02000400 
	IGNITER	INPUT CONNECTOR 02 SERIES MALE	02000500-A1-XX 

For specific part numbers to your application, see IGNITERS catalog section

EXCITERS

SURESPARK LO DUAL (07072404)

Two individual SureSpark LO exciters housed in a shared enclosure, designed to handle all AC power turbine applications. Includes full Chentronics Predictive Diagnostics capabilities.



Key Features

- Input Power 100-240 VAC
- Output 12 Joule @ 4 Sparks Per Second (SPS)
- ARP670 Type 5F output

Certifications: 



TYPICAL SURESPARK LO SYSTEM FOR FRAME 7FA TURBINES (NO. 2 OIL OR GAS)

	DESCRIPTION	FEATURES	TYPICAL PART NO.
DUAL EXCITER	SURESPARK LO EXCITER	<ul style="list-style-type: none"> • TWO-4SPS independent exciters • Diagnostic led indicators for tip wear • Stainless steel enclosure Output connectors (two): ARP670 TYPE 5F, pressure sealed Saves space when multiple exciters are required. 	07072404-GXI 
	HARNESS	<ul style="list-style-type: none"> • In-line pressure seal Flexible conduit Straight or elbow ends Input and output connectors: • ARP670 TYPE 5M DIV 2 & zone 2 rated 	RP44613NI 
ONE NEEDED PER EXCITER OUTPUT	IGNITER	<ul style="list-style-type: none"> • Patented flush gap tip $\varnothing 12$ mm section to enhance retraction $\varnothing 0.625$ in section for existing fit Input connector: ARP670 TYPE 5F, pressure sealed 	09002244-0521 

For specific part numbers to your application, see IGNITERS catalog section

EXCITERS

MTE (C7778002)

Our DC input system (MTE) is capable of handling all gaseous and light liquid fuels. It is turbine-ready, including full Chentronics predictive diagnostic capabilities.





Key Features

- Input Power 11-28 VDC
- Output 2 Joule @ 5 Sparks Per Second (SPS)
- ARP670 Type 2F output

Certifications:    



APPLICATIONS WITH EXCITER INSTALLED IN A NON-HAZARDOUS AREA

	DESCRIPTION	FEATURES	TYPICAL PART NO.
ONE NEEDED PER EXCITER OUTPUT	MTE	<ul style="list-style-type: none"> • 3-6 SPS Exciter • 11-28VDC Input Voltage • Spark Diagnostic for detecting tip wear • Output Connection: ARP670 Type 2F • 316 Stainless Steel • D50DIV 2/ZONE 2 rated 	<p>C7778002-UYZ</p> 
	INPUT HARNESS	<ul style="list-style-type: none"> • Custom length cable • Quick connect or flying leads available • HAZ-Loc and non-haz versions 	<p>03008002-1</p> 
	OUTPUT HARNESS	<ul style="list-style-type: none"> • Straight or Elbow Ends • Input and output connectors: ARP670 Type 2M • DIV 2 & zone 2 rated 	<p>RD442MNI-01</p> 
	IGNITER	<ul style="list-style-type: none"> • Patented flush gap tip • Many length and OD configurations possible • Input connection: ARP670 Type 2F 	<p>09000175</p> 

For specific part numbers to your application, see IGNITERS catalog section

EXCITERS

SURESPARK RF (07000502)

A system designed for marine and heavy fuel oil applications, including full Chentronics Predictive Diagnostics capabilities.







Key Features

- Input Power 100-240 VAC
- Output 12 Joule @ 20 Sparks Per Second (SPS)
- Various configurable output options

Certifications: CE

TYPICAL SURESPARK RF SYSTEM WITH 02 SERIES OUTPUT HARDWARE FOR NON-HAZARDOUS AREA APPLICATIONS (NO. 6 OIL)

	DESCRIPTION	FEATURES	TYPICAL PART NO.
SINGLE EXCITER	SURESPARK RF EXCITER	<ul style="list-style-type: none"> • 20SPS exciter • Diagnostic led indicators for tip wear • Output connection: two-wire MIL style • Painted steel or fiberglass enclosure • Optional momentary switch 	07000502-ZZ1 
	HARNESS	<ul style="list-style-type: none"> • Straight or elbow ends Input and output connectors: two-wire MIL style 	03000350 
ONE NEEDED PER EXCITER OUTPUT	BASE ROD	INPUT CONNECTOR Two-wire MIL style	02000300 
	EXTENSION ROD (OPTIONAL)	INPUT CONNECTOR 02 SERIES MALE	OUTPUT CONNECTOR 02 SERIES FEMALE 02000400 
	IGNITER	INPUT CONNECTOR 02 SERIES MALE	02000500-A2-XX 

For specific part numbers to your application, see IGNITERS catalog section

EXCITERS

SMARTSPARK (07000124/07000224)

Simplify your burner ignition with our direct mount 'On the Rod' ignition system. Certified to North American (07000124) and European (07000224) standards.







Key Features

- Input Power 100-240 VAC
- Output 4 Joule @ 15 Sparks Per Second (SPS)
- Chentronics Type 2 Output

Certifications:    



TYPICAL SMARTSPARK SYSTEM WITH 12 SERIES OUTPUT HARDWARE FOR HAZARDOUS AREA APPLICATIONS (NO. 2 OIL OR GAS)

DESCRIPTION	FEATURES	TYPICAL PART NO.
EXCITER & POWER CABLE	SMARTSPARK EXCITER <ul style="list-style-type: none"> • 100-240VAC 50/60Hz Input voltage • Stainless steel enclosure • Output connector: 02 series female 	<div style="display: flex; justify-content: space-around;"> <div style="text-align: center;"> <p>cETLus SYSTEM</p> <p>07000124-XX</p>  </div> <div style="text-align: center;"> <p>ATEX SYSTEM</p> <p>07000224-XX</p>  </div> </div> <p>OR</p>
	INPUT POWER CABLE	<div style="display: flex; justify-content: space-around;"> <div style="text-align: center;"> <p>C07000124</p>  </div> <div style="text-align: center;"> <p>C07000224</p>  </div> </div>
EXTENSION ROD (OPTIONAL)	INPUT CONNECTOR 02 SERIES MALE	OUTPUT CONNECTOR 12 SERIES FEMALE 12000450 
IGNITER	INPUT CONNECTOR 02 SERIES MALE 02000500-A1-12	INPUT CONNECTOR 02 SERIES 12000550-A1-12 12000500-A1-12  -Mates directly to SmartSpark -INCOMPATIBLE with 12000450 Extension Rod

INSERTION CALCULATION

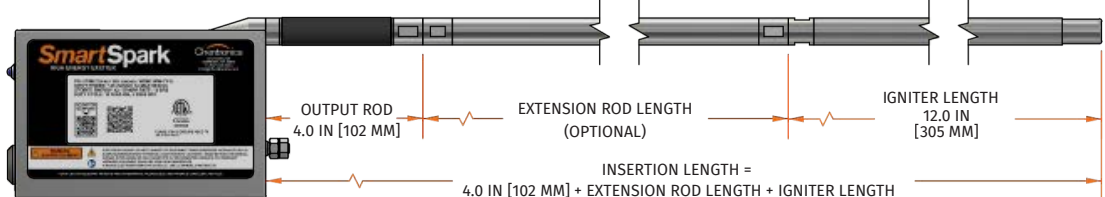

EXCITERS

Motivator 3(07171717)

Our hand held, battery powered system for all your remote ignition needs.



Key Features

- Battery Powered
- Output 1.5 Joule @ 6 Sparks Per Second (SPS)
- Chentronics Type 2 Output

Certifications: CE



TYPICAL MOTIVATOR SYSTEM WITH 12 SERIES OUTPUT HARDWARE FOR NON -HAZARDOUS AREA APPLICATIONS (GAS ONLY)

DESCRIPTION	FEATURES	TYPICAL PART NO.
MOTIVATOR EXCITER	<ul style="list-style-type: none"> • Handheld operation • Rechargeable battery (sold separately) • Output connector: 02 series female • Spark indicator light 	07171717 
EXTENSION ROD (OPTIONAL)	INPUT CONNECTOR 02 SERIES MALE	OUTPUT CONNECTOR 12 SERIES FEMALE 
IGNITER	INPUT CONNECTOR 02 SERIES MALE 12000500-A1-12	INPUT CONNECTOR 02 SERIES 12000550-A1-12 -Matesdirectly toSmartSpark -INCOMPATIBLE with 12000450 Extension Rod 

For specific part numbers to your application, see IGNITERS catalog section

IGNITER SIZING

Choosing the right igniter is crucial to your project's success. Chentronics offers a wide range of igniters. Here's how to select the best fit:



- 1 OUTER DIAMETER (OD)**
Ensure the igniter fits your existing guide tube. Our igniters are classified by OD, ranging from 0.875 in down to 8 mm, making your search easy.
The correct OD is the first step in your igniter selection.

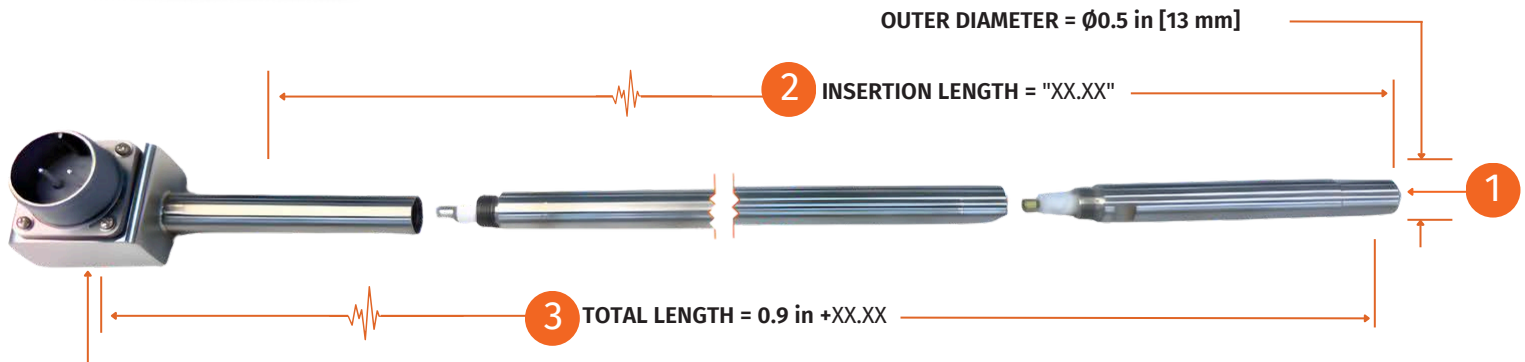

- 2 INSERTION LENGTH**
Determine how far the igniter's spark needs to reach inside the burner. Measure the distance from your burner opening to the spark location on your current hardware.
This distance defines the insertion length.
- 3 TOTAL LENGTH**
Account for any obstacle outside the burner such as fuel lines, air lines, walls, or railings. Add this clearance to your insertion length to get the igniter's total length.
Total length ensures the igniter clears all external obstructions.

CONNECTIONS LIST



TWO WIRE CONNECTION



E SERIES CONNECTION

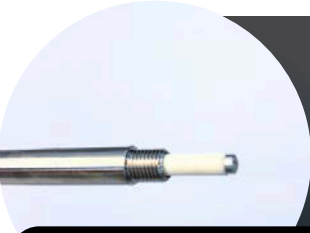
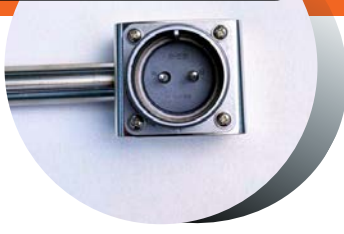

12 SERIES CONNECTION



02 SERIES CONNECTION

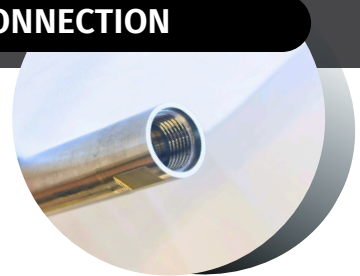
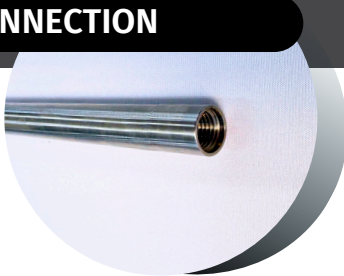

ARP 670 TYPE 5



ARP 670 TYPE 2



HARNESSES AND RODS

Connecting your exciter to your igniter is simple with Chentronics. Choose the exciter and igniter that fit your unit, match the connectors, and specify the required length for your setup.

All of our harnesses are custom-made to your specifications and can be tailored to any length you need. Our rods are available in lengths ranging from 6 inches to 12 feet, accommodating your specific insertion requirements. We make integration easy and precise for optimal performance.

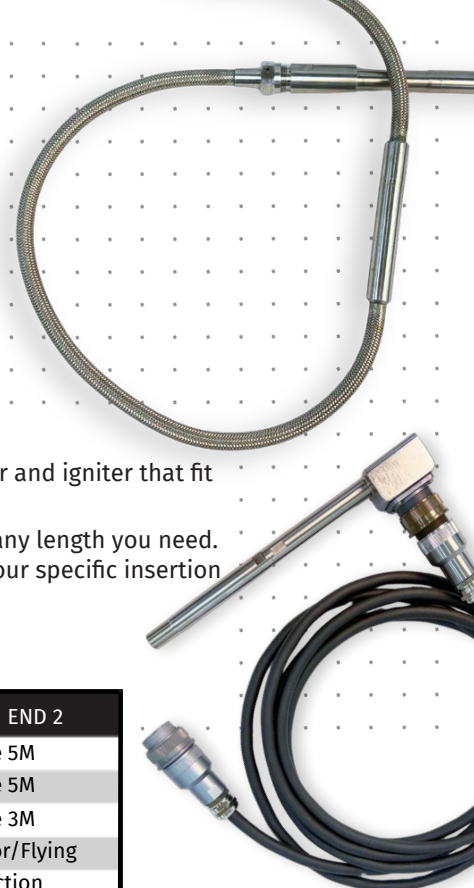

OUTPUT CABLES

HARNESS TYPE	PART NUMBER	CONNECTION END 1	CONNECTION END 2
Class 1 Div 2 pressure sealed	RP44613NI-XX-XXX	ARP670 type 5M	ARP670 type 5M
Class 1 Div 2 unsealed	RD44613NI-XX-XXX	ARP670 type 5M	ARP670 type 5M
Class 1 Div 2 unsealed	RD442MNI-XX-XXX	ARP670 type 3M	ARP670 type 3M
2 Wire Harness	03000350-XX-XXX	2 Wire Connector	2 Wire Connector/Flying
Flare Harness	06000006-XX.XX	EXD enclosure	Flare Connection
EXD Harness	06000115-X.XX	1/2" NPT	1/2" NPT
Class 1 Div 2 type 3 to type 5	D7780000-XX-XXX	ARP670 type 3M	ARP670 type 5M

EXCITER END	IGNITER END	FLEX	PART NUMBER	LENGTH	SPACER
2 Wire Connector	02 Series	No	02000300	4"	N/A
2 Wire Connector	12 Series	No	12000300	4"	N/A
02 Series	02 Series	No	02000400	6"-13'	N/A
ARP670 Type 5F	E Series	No	E78776	Variable	N/A
02 Series	E Series	No	01000033	Variable	N/A
ARP670 Type 3M	2221122	Yes	01000039F	Variable	N/A
ARP670 Type 3M	2221122	No	01000040	Variable	N/A
02 Series	02 Series	Yes	02000033F	Variable	N/A
2 Wire Connector	02 Series	No	02000373	Variable	0.875" OD Spacer
02 Series	02 Series	No	02000425	Variable	30" long 0.875 OD Spacer
EXD Box	02 Series	No	02700350	Variable	N/A
EXD Box	E Series	No	06000003	Variable	N/A
Triax	Triax	No	04004400	Variable	N/A
Triax	Triax	No	04000400	Variable	N/A
EXD Box	02 Series	No	02700300	4"	N/A
ARP670 Type 5M	12 Series	No	12000475	8"-10'	N/A

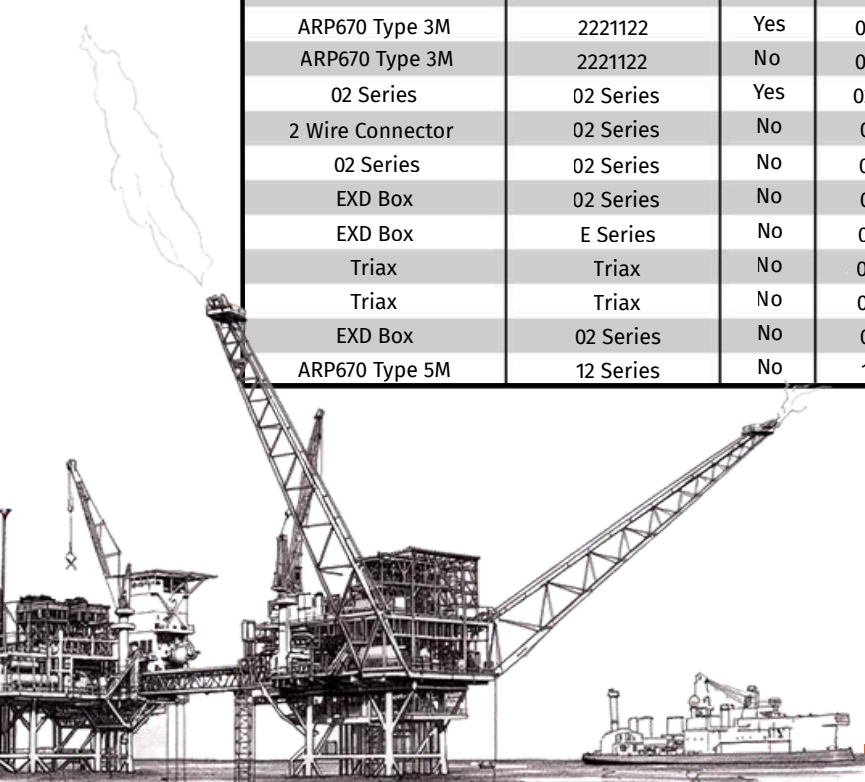

IGNITERS

If you're in search of an igniter for boilers, burners, pilots or other applications, Chentronics offers a diverse selection to meet your needs. Our igniters range in outer diameters from 8mm (0.31") to 0.675", ensuring we have a solution that fits your specific requirements. Explore our range to find the perfect igniter for your application:

CONNECTION TYPE	TIP OD	PART NUMBER	WORKS WITH
02 Series	0.675"	02000500	SmartSpark, LO, RF, Motivator
02 Series	12mm	12000550	SmartSpark, LO, Motivator
02 Series	0.25"	02000008F	SmartSpark, LO
02 Series	0.25"	02000008	SmartSpark, LO, Motivator
02 Series	0.675"	02000036F	SmartSpark, LO, RF, Motivator
02 Series	0.5"	02000037F	SmartSpark, LO
02 Series	0.675"	02000630	SmartSpark, LO, RF, Motivator
02 Series	0.5"	01000730	SmartSpark, LO, Motivator
12 Series	12mm	12000500	SmartSpark, LO
12 Series	12mm	12030500	SmartSpark, LO
12 Series	12mm	12030550	SmartSpark, LO
12 Series	8mm	12000508	SmartSpark, LO
E Series	0.625"	E93135	LO, RF
E Series	0.625"	E93135-0.58	LO, RF
E Series	0.625"	E90258	LO, RF
E Series	0.625"	E99960	LO, RF
E Series	0.625"	05000001	LO, RF
E Series	0.625"	05000013	LO, RF
Flare	0.675"	05000005A30	LO
Flare	0.675"	05000005	LO
Flare	0.675"	05000034	LO
flying lead w/ 3/4" NPT	0.5"	01000728	LO
9/16-18 UNF 2A	0.5"	222122	LO
9/16-18 UNF 2A	0.5"	01000700	LO
9/16-18 UNF 2A	0.625"	01000710	LO
ARP670 Type 2M	12mm	01000735	MTE

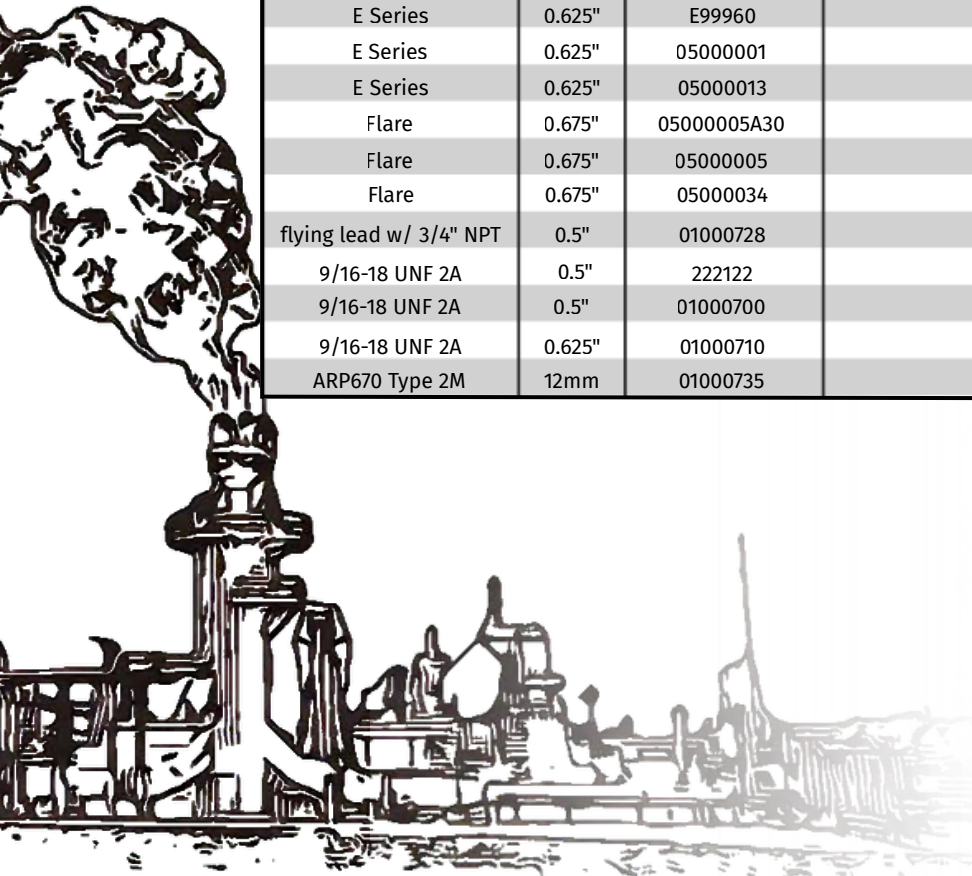

TURBINE IGNITERS

Turbines are unique and require incredibly precise igniters to function optimally. Our systems have been successfully installed and tested across a wide range of turbine models. Refer to the table below to see if we offer the perfect ignition solution for your turbine:



CONNECTION TYPE	OD	FRONT THREADS	TURBINE	PART NUMBER
EXD Box	0.44"	M27x2-6G	Alstom 13E2	09000002
ARP670 Type 2F	0.56"	15/16-16 UN-2A	Pratt & Whitney JT4	09000066
ARP670 Type 2F	8mm	N/A	BorgWarner TG350	09000068
ARP670 Type 2F	0.469"	11/16-24 UNEF-3A	Rolls Royce Avon Mark 1535	09000065
ARP670 Type 2F	8mm	M21x1-6G	Siemens v84.2	09000375
ARP670 Type 5F	0.625"	7/8-20 UNEF 2A	Westinghouse 251/501B	09000044
ARP670 Type 5F	0.625"	7/8-20 UNEF 2A	Westinghouse 171/191/501D4	09000045
ARP670 Type 5F	12mm	G 1/2-14-A	PSM	09000054
ARP670 Type 5F	12mm	G 1/2-14-A	Ansaldo GT36	09000057
ARP670 Type 5F	12mm	G 3/4-14-A	PSM	09000061
ARP670 Type 5F	12mm	M20x1	Siemens/Ruston SGT400	09000325
ARP670 Type 5F	9.4mm	11/16-24 UNEF-2A	Vericor TF/ASE	09000400
ARP670 Type 5F	12mm	3/4-20 UNEF-2A	GE 7EA, 7EA-DLN, 7B, 9, 9E, 9F	09000750
ARP670 Type 5F	12mm	M18x1.5-6G	Westinghouse 501F	09000069
ARP670 Type 5F	0.625"	M18x1.5-6G	Westinghouse 501G	09000807
ARP670 Type 5F	12mm	M18x1.5-6G	Westinghouse 501F Alternate	09000808
ARP670 Type 5F	12mm	3/4-16 Compression Fitting	GE 7EA Ball and Socket	09000904
ARP670 Type 5F	12mm	7/8-20 Compression Fitting	GE 7EA/GE 7FA Alternate	09002233
ARP670 Type 5F	0.625"	7/8-20 Compression Fitting	GE 7FA, 7HA.02, 9FA.03 DLN2+	09002244
ARP670 Type 5F	1.0"	M14x1.25-6G	N/A	01000308
ARP670 Type 5F	12mm	11/16-24 UNEF-2A	Vericor TF/ASE	300-30187-02
ARP670 Type 5F	0.625"	3/4 FNPT	N/A	01000850
ARP670 Type 5F	0.5"	3/4" NPT	N/A	P01000705
Frame 5	0.625"	3/4-20 UNEF	GE Frame 5/7 Front Load	09000001

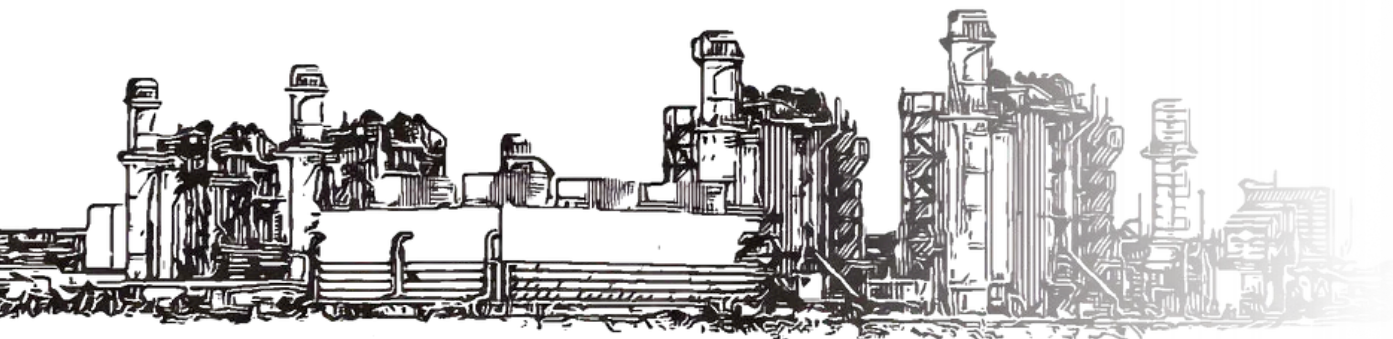

TURBINE SYSTEMS

Chentronics Turbine Compatibility

Chentronics systems have been successfully installed and tested on a wide variety of turbines. For turbines listed below, our parts provide a direct 1-for-1-plug-and-play replacement for an easy upgrade:

MANUFACTURER	FRAME	EXCITER	INPUT CABLE	OUTPUT CABLE	IGNITER
ALSTOM	13E2	07072404-GXI	N/A	06000115	09000002
ALSTOM (RUSTON)	TA/TB/Tornado	07072404-GXI	N/A	RP44613NI	01000308
ANSALDO	GT36	07072404-GXI	N/A	RP44613NI	09000057-0563
GE	5 Front Load	07072404-GXI	N/A	RP44613NI	09000001
	5 Back Load	07072404-GXI	N/A	RP44613NI	09000750-0364
	6	07072404-GXI	N/A	RP44613NI	09000750-0364
	7 & 7B	07072404-GXI	N/A	RP44613NI	09000750-0364
	7EA	07072404-GXI	N/A	RP44613NI	09000750-0420
	7EA Non-Retract	07072404-GXI	N/A	RP44613NI	09002233-0279-0200
	7EA DLN	07072404-GXI	N/A	RP44613NI	09000750-0279
	7EA Ball & Socket	07072404-GXI	N/A	RP44613NI	09000904-0279
	7FA	07072404-GXI	N/A	RP44613NI	09002244(09002233)
	7HA.03	135T0234P0011	N/A	135T0236PXXXX	135T0235P0001
	9	07072404-GXI	N/A	RP44613NI	09000750-0425
	9E	07072404-GXI	N/A	RP44613NI	09000750-0450
	9F	07072404-GXI	N/A	RP44613NI	09000750-0375
	LM6000/2500		C7778002-UYZ	03008002	RD442MNI
9HA.01 & .02		135T0234P0011	135T0236P0040	135T0235P0001	09000058
MITSUBISHI	191	07072404-GXI	N/A	RP44613NI	09000205
	501G	07072404-GXI	N/A	RP44613NI	090501GM-1162
PRATT & WHITNEY	JP8	C7778002-UYZ	03008002	RD442MNI	09000066
PSM	7FA Flame Sheet	07072404-GXI	N/A	RP44613NI	09000061-0279
ROLLS ROYCE	Avon Mark 1535	C7778002-UYZ	03008002	RD442MNI	09000065
SIEMENS/ WESTINGHOUSE	W171 & W191	07072404-GXI	N/A	RP44613NI	09000045
	251	07072404-GXI	N/A	RP44613NI	09000004
	501F	07072404-GXI	N/A	RP44613NI	09000069
	501G	07072404-GXI	N/A	RP44613NI	09000807
	501D4	07072404-GXI	N/A	RP44613NI	09000045

IF YOUR TURBINE ISN'T LISTED PLEASE GIVE US A CALL (607) 334-5531. WE'RE EAGER TO EXPLORE NEW OPPORTUNITIES AND ADD YOUR TURBINE TO OUR GROWING CATALOG.

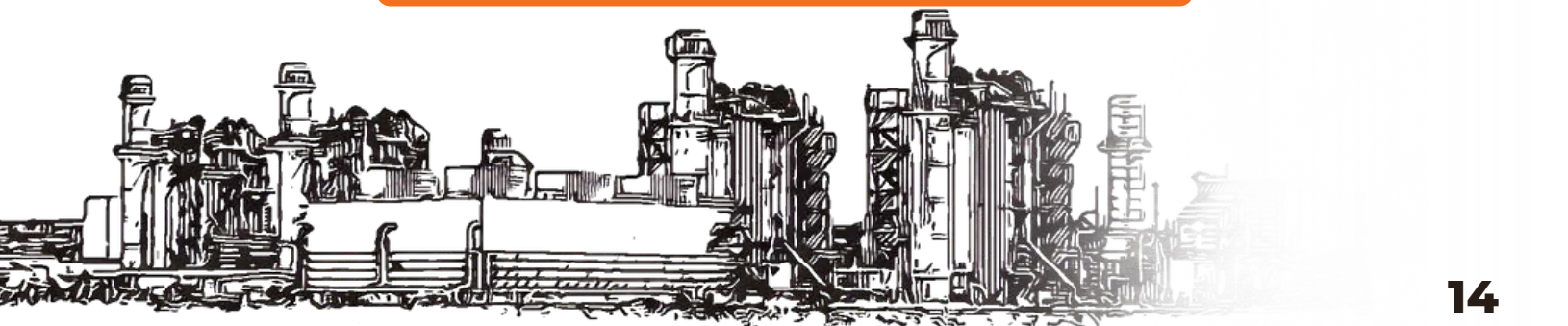



iScan[®]3+

The Chentronics iScan3+ is an all-in-one solution designed to meet diverse fuel conditions with its dual UV and IR sensor capabilities. This ensures you always have the right tool for the job.

iScan3+ SELECTION TABLE				
Do you need marine capability?	Yes 04005100-B1		No 04005100-A1	
Do you need flame discrimination?	Yes 04005100-B1-MB	No 04005100-B1-SB	Yes 04005100-A1-MB	No 04005100-A1-SB
Do you need a response time delay?	No N/A	Yes 04005100-B1-SB-04	No N/A	Yes 04005100-A1-SB-04

Advanced Features

- **Bluetooth Connectivity:** Built-in, read-only Bluetooth enables real-time data viewing and recording on connected devices for easy troubleshooting and data acquisition.
- **Ring of Light:** Provides clear visual feedback on burner conditions, helping operators monitor flames and maintain equipment effectively.
- **Dual-Spectrum Flame Detection:** Simultaneous UV and IR sensors deliver superior flame discrimination and reliable operation in diverse conditions.

Certifications:   



Choose the iScan3+ for comprehensive flame scanning technology that enhances operational efficiency and equipment management.

iScan3+ FIBER OPTICS & ACCESSORIES

Harsh environments with high vibration and temperature can shorten detector life, increase costs, and often require complex solutions like air or liquid cooling. The Chentronics iScan3+ offers a smarter alternative: remote mounting. Place the iScan3+ safely away from these conditions and use a fiber optic cable at the burner location instead.

Proven across turbines, burners, and boilers, this system protects critical electronics while delivering the same reliable data as a direct mount. Custom fiber optic cables ensure clear flame visibility and simplify maintenance through convenient remote access.

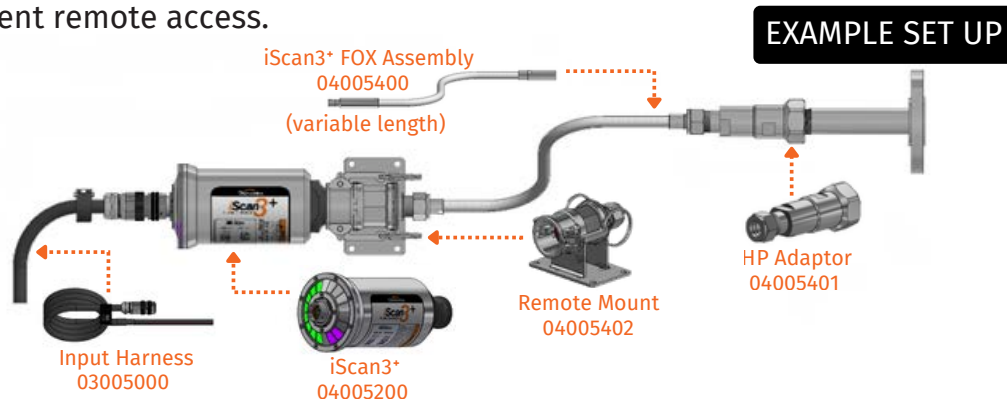

In addition to remote mounting via fiber optic cable, Chentronics offers a variety of other key accessories for iScan3+:

- **IR Filter (04000120):** Enhances iScan3+ performance in gaseous applications when other flames are in the area by blocking visible and IR wavelengths above 750 nm while passing UV near 310 nm—reducing false alarms and improving discrimination of background flames.
- **Power Supply Display Module (04005800):** Provides reliable 120/220 VAC → 24 VDC conversion and centralizes wiring for the iScan quick-connect, with a local visual display of flame, signal, and faults to speed diagnostics and minimize downtime.
- **Flame Simulator (04005700):** Portable, calibrated UV reference source (USB-C, long battery life) that lets technicians verify and troubleshoot iScan3+ performance in the field, cutting service time and ensuring measurement confidence.
- **Remote Mounted Ring of Light (04005815):** Remote visual indicator for cabinets or field enclosures that shows live flame status without opening panels, improving safety and reducing unnecessary maintenance visits.





Chentronics®

IGNITING INNOVATION



[\(607\) 334-5531](tel:(607)334-5531)



WWW.CHENTRONICS.COM